

TK-980/981

SERVICE MANUAL

SUPPLEMENT II

This service manual applied product with 50100001 (TK-980), 60600001 (TK-981) or subsequent serial numbers.

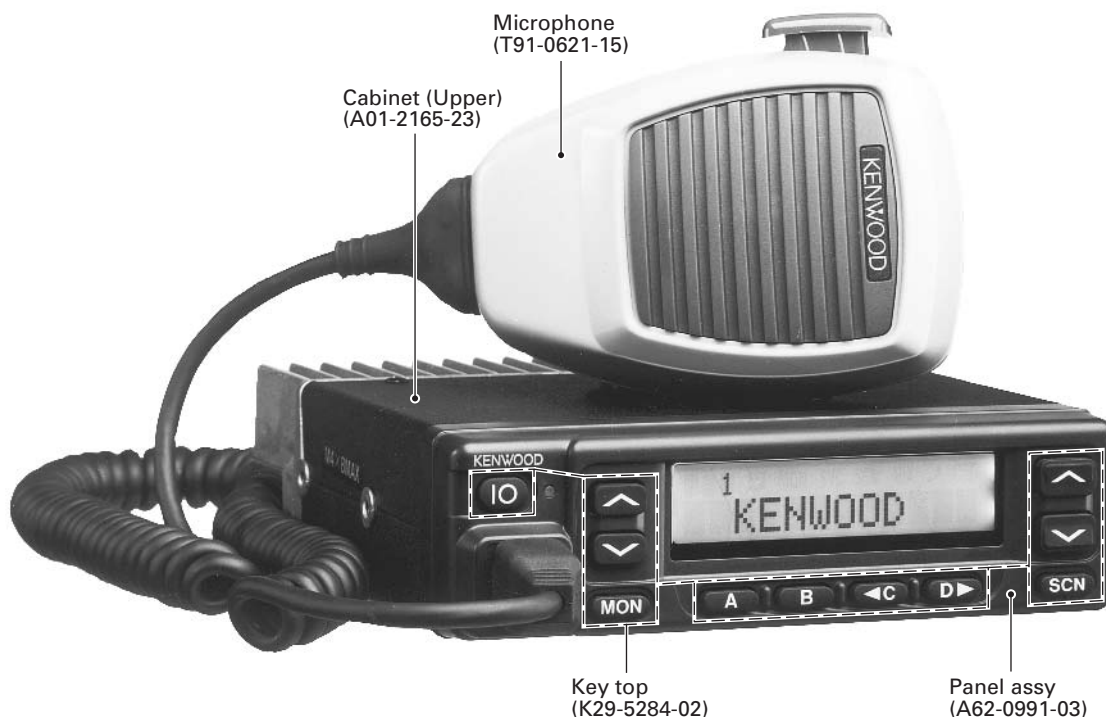

CONTENTS

PARTS LIST	2
PC BOARD	
PLL/VCO (X58-453X-XX)	7
TX-RX UNIT (X57-652X-XX) (A/2)	8
SCHEMATIC DIAGRAM.....	12

TK-980/981

PARTS LIST

* New Parts. Δ indicates safety critical components.

Parts without **Parts No.** are not supplied.

Les articles non mentionnés dans le **Parts No.** ne sont pas fournis.

Teile ohne **Parts No.** werden nicht geliefert.

L : Scandinavia

Y : PX (Far East, Hawaii)

Y : AAFES (Europe)

K : USA

T : England

X : Australia

P : Canada

E : Europe

M : Other Areas

TX-RX UNIT (X57-6520-XX)

Ref. No.	Address	New parts	Parts No.	Description	Destination
TX-RX UNIT (X57-652X-XX) 0-10 : TK-980 0-11 : TK-981					
D511			B30-2151-05	LED (RED/GREEN)	
D512-517			B30-2171-05	LED	
C1-15			CC73GCH1H101J	CHIP C 100PF J	
C16			C92-0628-05	CHIP-TAN 10UF 10WV	
C18			C92-0507-05	CHIP-TAN 4.7UF 6.3WV	
C19			CC73GCH1H100D	CHIP C 10PF D	
C20-22			CC73GCH1H101J	CHIP C 100PF J	
C23			C92-0507-05	CHIP-TAN 4.7UF 6.3WV	
C24			CC73GCH1H101J	CHIP C 100PF J	
C25			C92-0507-05	CHIP-TAN 4.7UF 6.3WV	
C27			CK73GB1H102K	CHIP C 1000PF K	
C28			CC73GCH1H220J	CHIP C 22PF J	
C29			C92-0628-05	CHIP-TAN 10UF 10WV	
C30			CK73GB1H102K	CHIP C 1000PF K	
C31			C92-0628-05	CHIP-TAN 10UF 10WV	
C32			CC73GCH1H100D	CHIP C 10PF D	
C33			CK73GB1E103K	CHIP C 0.010UF K	
C34			C92-0568-05	CHIP-TAN 22UF 10WV	
C35			CC73GCH1H101J	CHIP C 100PF J	
C36			C92-0628-05	CHIP-TAN 10UF 10WV	
C37			C92-1341-05	ELECTRO 100UF 16WV	
C38			C92-0507-05	CHIP-TAN 4.7UF 6.3WV	
C39			CK73GB1E103K	CHIP C 0.010UF K	
C40			CC73GCH1H101J	CHIP C 100PF J	
C41			C92-0628-05	CHIP-TAN 10UF 10WV	
C42			C92-0546-05	CHIP-TAN 68UF 6.3WV	
C43,44			CC73GCH1H101J	CHIP C 100PF J	
C45			C92-0507-05	CHIP-TAN 4.7UF 6.3WV	
C46			C92-0004-05	CHIP-TAN 1.0UF 16WV	
C47			CC73GCH1H101J	CHIP C 100PF J	
C48			CK73FF1C105Z	CHIP C 1.0UF Z	
C49			CC73GCH1H101J	CHIP C 100PF J	
C51			CC73GCH1H101J	CHIP C 100PF J	
C52			CC73GCH1H100D	CHIP C 10PF D	
C54			CK73GB1C104K	CHIP C 0.10UF K	
C55			CC73GCH1H030C	CHIP C 3.0PF C	
C56			CC73GCH1H101J	CHIP C 100PF J	
C57			CK73GB1E103K	CHIP C 0.010UF K	
C58			CC73GCH1H101J	CHIP C 100PF J	
C59			CC73GCH1H030C	CHIP C 3.0PF C	
C60			CC73GCH1H101J	CHIP C 100PF J	
C61			CK73GB1E103K	CHIP C 0.010UF K	
C62			CC73GCH1H030C	CHIP C 3.0PF C	
C63			CK73FF1C105Z	CHIP C 1.0UF Z	
C64			CC73GCH1H101J	CHIP C 100PF J	
C65			CK73GB1C104K	CHIP C 0.10UF K	
C66			CK73GB1E103K	CHIP C 0.010UF K	
C67			CC73GCH1H101J	CHIP C 100PF J	
C68			CK73GB1C104K	CHIP C 0.10UF K	
C70			C92-0719-05	ELECTRO 47UF 25WV	
C71			CK73GB1C104K	CHIP C 0.10UF K	
C72,73			CK73GB1H102K	CHIP C 1000PF K	
C74			C92-0719-05	ELECTRO 47UF 25WV	
C75			C92-0044-05	CHIP-ELE 47UF 10WV	
C76			CK73GB1H102K	CHIP C 1000PF K	
C77			C92-0719-05	ELECTRO 47UF 25WV	
C78			CK73GB1E103K	CHIP C 0.010UF K	
C79			C92-0722-05	ELECTRO 470UF 16WV	
C80			CK73GB1C104K	CHIP C 0.10UF K	
C83			CK73FB1H473K	CHIP C 0.047UF K	
C84			CC73GCH1H120J	CHIP C 12PF J	TK-980
C84			CC73GCH1H220J	CHIP C 22PF J	TK-981
C85			CK73GB1H102K	CHIP C 1000PF K	
C87			CC73GCH1H101J	CHIP C 100PF J	
C88			CK73GB1E103K	CHIP C 0.010UF K	
C89			CK73GB1H471K	CHIP C 470PF K	
C90			CK73GB1H102K	CHIP C 1000PF K	
C91,92			CK73GB1E103K	CHIP C 0.010UF K	
C94			CK73GB1H471K	CHIP C 470PF K	
C96			CC73GCH1H180J	CHIP C 18PF J	
C97			CK73GB1H102K	CHIP C 1000PF K	
C98			CC73GCH1H150J	CHIP C 15PF J	
C99			CK73GB1H102K	CHIP C 1000PF K	
C100			C92-0628-05	CHIP-TAN 10UF 10WV	TK-980
C102			CC73GCH1H270J	CHIP C 27PF J	
C103			CK73GB1C104K	CHIP C 0.10UF K	
C104			CK73GB1E103K	CHIP C 0.010UF K	
C105			C92-0004-05	CHIP-TAN 1.0UF 16WV	
C106			CK73GB1H102K	CHIP C 1000PF K	
C107			C92-0628-05	CHIP-TAN 10UF 10WV	
C108			CK73GB1C104K	CHIP C 0.10UF K	
C109,110			CK73GB1H102K	CHIP C 1000PF K	
C111			CC73GCH1H101J	CHIP C 100PF J	
C112			CK73GB1H102K	CHIP C 1000PF K	
C113			CK73GB1E103K	CHIP C 0.010UF K	
C114			C92-0543-05	CHIP-TAN 3.3UF 10WV	
C115			CK73GB1H102K	CHIP C 1000PF K	
C116			C92-0507-05	CHIP-TAN 4.7UF 6.3WV	
C117			CK73GB1E103K	CHIP C 0.010UF K	
C118			CK73GB1C104K	CHIP C 0.10UF K	
C121			C92-0543-05	CHIP-TAN 3.3UF 10WV	
C123			CK73GB1C104K	CHIP C 0.10UF K	
C124,125			CK73GB1H102K	CHIP C 1000PF K	
C126			CK73GB1C104K	CHIP C 0.10UF K	
C127			CK73GB1E103K	CHIP C 0.010UF K	
C128,129			CC73GCH1H470J	CHIP C 47PF J	
C131			CC73GCH1H101J	CHIP C 100PF J	
C132			CK73GB1C104K	CHIP C 0.10UF K	
C134			CK73FB1C224K	CHIP C 0.22UF K	
C136			CK73FB1C224K	CHIP C 0.22UF K	
C137			CK73GB1H471K	CHIP C 470PF K	
C142,143			CK73GB1H471K	CHIP C 470PF K	
C144			CK73GB1H102K	CHIP C 1000PF K	
C150			CC73GCH1H220J	CHIP C 22PF J	
C151			CK73GB1H102K	CHIP C 1000PF K	
C152			C92-0777-05	ELECTRO 1000UF 25WV	
C153			CC73GCH1H100D	CHIP C 10PF D	
C155			CK73GB1H102K	CHIP C 1000PF K	

PARTS LIST

TX-RX UNIT (X57-6520-XX)

Ref. No.	Address	New parts	Parts No.	Description	Desti-nation	Ref. No.	Address	New parts	Parts No.	Description	Desti-nation
C156			CK73GB1E103K	CHIP C 0.010UF K		C262			C92-0719-05	ELECTRO 47UF 25WV	
C157			CK73GB1C104K	CHIP C 0.10UF K		C263			CK73GB1H102K	CHIP C 1000PF K	
C158,159			CC73GCH1H040C	CHIP C 4.0PF C		C264			CK73GB1C104K	CHIP C 0.10UF K	
C160			CK73GB1C104K	CHIP C 0.10UF K		C265			C93-0550-05	CHIP C 1.0PF C	
C161			CC73GCH1H101J	CHIP C 100PF J		C266			C93-0552-05	CHIP C 2.0PF C	TK-981
C162			C92-0585-05	CHIP-TAN 4.7UF 16WV		C266			C93-0555-05	CHIP C 5.0PF C	TK-980
C164			CK73GB1H471K	CHIP C 470PF K		C267			C93-0568-05	CHIP C 47PF J	
C166			CK73GB1C104K	CHIP C 0.10UF K		C268			CC73FCH1H010C	CHIP C 1.0PF C	TK-981
C167			CC73GCH1H100D	CHIP C 10PF D		C268			CC73FCH1H470J	CHIP C 47PF J	TK-980
C168			CC73GCH1H080D	CHIP C 8.0PF D		C269			C93-0560-05	CHIP C 10PF D	
C169			CK73GB1H102K	CHIP C 1000PF K		C271			C93-0550-05	CHIP C 1.0PF C	
C170			CC73GCH1H050C	CHIP C 5.0PF C	TK-981	C272			CC73GCH1H010C	CHIP C 1.0PF C	
C170			CC73GCH1H070B	CHIP C 7.0PF B	TK-980	C273			C93-0552-05	CHIP C 2.0PF C	TK-981
C171			CC73GCH1H101J	CHIP C 100PF J		C273			C93-0553-05	CHIP C 3.0PF C	TK-980
C172			CK73GB1C104K	CHIP C 0.10UF K		C274			CC73GCH1H221J	CHIP C 220PF J	
C173			CK73GB1E103K	CHIP C 0.010UF K		C275			C92-0002-05	CHIP-TAN 0.22UF 35WV	
C174			C92-0585-05	CHIP-TAN 4.7UF 16WV		C276			C92-0657-05	CHIP-TAN 2.2UF 20WV	TK-981
C175			CC73GCH1H101J	CHIP C 100PF J	TK-980	C276			C92-0754-05	CHIP-TAN 4.7UF 20WV	TK-980
C175,176			CC73GCH1H101J	CHIP C 100PF J	TK-981	C284			CC73GCH1H470J	CHIP C 47PF J	
C176			CC73GCH1H470J	CHIP C 47PF J	TK-980	C286			CC73GCH1H470J	CHIP C 47PF J	
C177			C92-0519-05	CHIP-TAN 1.0UF 25WV		C289			CK73GB1E103K	CHIP C 0.010UF K	
C178			CC73GCH1H470J	CHIP C 47PF J	TK-980	C303			C92-0565-05	CHIP-TAN 6.8UF 10WV	
C179			CC73GCH1H101J	CHIP C 100PF J	TK-981	C304			CC73GCH1H101J	CHIP C 100PF J	
C195-198			CK73GB1H102K	CHIP C 1000PF K		C306			CC73GCH1H101J	CHIP C 100PF J	
C207			CC73GCH1H101J	CHIP C 100PF J		C307			CK73GB1H103K	CHIP C 0.010UF K	
C209			CC73GCH1H101J	CHIP C 100PF J		C308			CC73GCH1H2R5B	CHIP C 2.5PF B	
C210			CC73GCH1H030C	CHIP C 3.0PF C		C309			CC73GCH1H010B	CHIP C 1.0PF B	
C211			CC73GCH1H101J	CHIP C 100PF J		C310			CC73GCH1H1R5B	CHIP C 1.5PF B	TK-981
C212			CC73GCH1H050C	CHIP C 5.0PF C		C310			CC73GCH1H2R5B	CHIP C 2.5PF B	TK-980
C213			CC73GCH1H010B	CHIP C 1.0PF B		C313			CC73GCH1H101J	CHIP C 100PF J	
C214,215			CC73GCH1H101J	CHIP C 100PF J		C314			C92-0001-05	CHIP-TAN 0.1UF 35WV	TK-980
C216			CC73GCH1H010B	CHIP C 1.0PF B	TK-981	C314			C92-0503-05	CHIP-TAN 0.068UF 35WV	TK-981
C216			CC73GCH1H1R5B	CHIP C 1.5PF B	TK-980	C315			CK73GB1C104K	CHIP C 0.10UF K	
C217			CK73GB1H102K	CHIP C 1000PF K		C317			CC73GCH1H101J	CHIP C 100PF J	
C218			CC73GCH1H101J	CHIP C 100PF J		C318,319			CK73GB1C104K	CHIP C 0.10UF K	
C219			CC73GCH1H110J	CHIP C 11PF J	TK-980	C320			C92-0003-05	CHIP-TAN 0.47UF 25WV	TK-981
C219			CC73GCH1H120J	CHIP C 12PF J	TK-981	C320			C92-0519-05	CHIP-TAN 1.0UF 25WV	TK-980
C220			CC73GCH1H101J	CHIP C 100PF J		C321			CC73GCH1H040C	CHIP C 4.0PF C	
C221			CK73GB1H102K	CHIP C 1000PF K		C322			C92-0003-05	CHIP-TAN 0.47UF 25WV	TK-981
C222			CC73GCH1H101J	CHIP C 100PF J		C322			C92-0519-05	CHIP-TAN 1.0UF 25WV	TK-980
C224			CK73GB1H102K	CHIP C 1000PF K		C325			C92-0003-05	CHIP-TAN 0.47UF 25WV	TK-981
C227			CK73GB1H103K	CHIP C 0.010UF K		C325			C92-0519-05	CHIP-TAN 1.0UF 25WV	TK-980
C228			CK73GB1H102K	CHIP C 1000PF K		C326			CK73FB1C154K	CHIP C 0.15UF K	
C229			CK73GB1H103K	CHIP C 0.010UF K		C327			CC73GCH1H101J	CHIP C 100PF J	
C234			CC73GCH1H101J	CHIP C 100PF J	TK-981	C328			CK73GB1H471K	CHIP C 470PF K	
C234			CC73GCH1H150J	CHIP C 15PF J	TK-980	C330			CC73FCH1H150J	CHIP C 15PF J	TK-980
C235			CC73GCH1H020B	CHIP C 2.0PF B		C330			CC73FCH1H470J	CHIP C 47PF J	TK-981
C236			CC73GCH1H101J	CHIP C 100PF J		C401-405			CC73GCH1H020B	CHIP C 2.0PF B	
C240			CK73GB1E103K	CHIP C 0.010UF K		C437			CK73GB1H102K	CHIP C 1000PF K	
C245			CC73GCH1H101J	CHIP C 100PF J		C438			CC73GCH1H220J	CHIP C 22PF J	
C246			C92-0001-05	CHIP-TAN 0.1UF 35WV		CN1			E40-5737-05	PIN ASSY	
C247			CC73GCH1H101J	CHIP C 100PF J		CN2			E40-5738-05	PIN ASSY	
C249			CC73GCH1H100D	CHIP C 10PF D		CN3			E40-3247-05	PIN ASSY	
C252			CK73GB1H102K	CHIP C 1000PF K		CN4			E40-5738-05	PIN ASSY	
C253			CC73FCH1H060D	CHIP C 6.0PF D	TK-980	CN5			E40-3247-05	PIN ASSY	
C253			CC73FCH1H080D	CHIP C 8.0PF D	TK-981	CN6			E40-3246-05	PIN ASSY	
C255			CC73FCH1H040C	CHIP C 4.0PF C	TK-981	CN7			E40-5982-05	FLAT CABLE CONNECTOR	
C255			CC73FCH1H100D	CHIP C 10PF D	TK-980	J1			E11-0442-05	3.5D PHONE JACK (3P)	
C256			CK73GB1H102K	CHIP C 1000PF K		-			J31-0543-05	COLLAR	
C258			CK73GB1C104K	CHIP C 0.10UF K							

TK-980/981

PARTS LIST

TX-RX UNIT (X57-6520-XX)

Ref. No.	Address	New parts	Parts No.	Description	Destination	Ref. No.	Address	New parts	Parts No.	Description	Destination
CF1			L72-0986-05	CERAMIC FILTER	TK-981	R27			RK73GB1J473J	CHIP R 47K J 1/16W	
CF1			L72-0998-05	CERAMIC FILTER	TK-980	R28			R92-1252-05	CHIP R 0 OHM J 1/16W	
L1			L40-4795-34	SMALL FIXED INDUCTOR (4.7UH)		R29			RK73GB1J220J	CHIP R 22 J 1/16W	
L3,4			L40-1875-92	SMALL FIXED INDUCTOR (18NH)		R30			RK73GB1J224J	CHIP R 220K J 1/16W	
L5			L40-1092-34	SMALL FIXED INDUCTOR		R31			RK73GB1J104J	CHIP R 100K J 1/16W	
L6			L34-4459-05	COIL		R32,33			RK73GB1J474J	CHIP R 470K J 1/16W	
L8			L92-0138-05	CHIP FERRITE		R34			R92-1252-05	CHIP R 0 OHM J 1/16W	
L9			L40-8265-92	SMALL FIXED INDUCTOR (8.2NH)		R36			RK73GB1J103J	CHIP R 10K J 1/16W	
L10			L40-1092-34	SMALL FIXED INDUCTOR		R37			R92-1252-05	CHIP R 0 OHM J 1/16W	
L11			L40-1091-37	SMALL FIXED INDUCTOR (1.000UH)		R39			RK73GB1J101J	CHIP R 100 J 1/16W	
L203			L79-1465-05	DIELECTRIC FILTER	TK-980	R40			RK73GB1J472J	CHIP R 4.7K J 1/16W	
L203			L79-1467-05	DIELECTRIC FILTER	TK-981	R41			RK73GB1J183J	CHIP R 18K J 1/16W	
L205			L40-1075-92	SMALL FIXED INDUCTOR (10NH)	TK-981	R42			RK73GB1J333J	CHIP R 33K J 1/16W	
L205,206			L40-8265-92	SMALL FIXED INDUCTOR (8.2NH)	TK-980	R44,45			RK73GB1J154J	CHIP R 150K J 1/16W	
L206			L40-6865-92	SMALL FIXED INDUCTOR (6.8NH)	TK-981	R46			RK73GB1J104J	CHIP R 100K J 1/16W	
L207			L79-1465-05	DIELECTRIC FILTER	TK-980	R47			RK73GB1J473J	CHIP R 47K J 1/16W	
L207			L79-1467-05	DIELECTRIC FILTER	TK-981	R48			RK73GB1J122J	CHIP R 1.2K J 1/16W	
L208			L40-4763-92	SMALL FIXED INDUCTOR (4.7NH)		R49			RK73GB1J102J	CHIP R 1.0K J 1/16W	
L209			L40-8265-92	SMALL FIXED INDUCTOR (8.2NH)		R50			RK73GB1J103J	CHIP R 10K J 1/16W	
L210			L40-3985-45	SMALL FIXED INDUCTOR (0.39UH)		R52			RK73GB1J104J	CHIP R 100K J 1/16W	
L211			L40-6885-45	SMALL FIXED INDUCTOR (0.68UH)		R53			R92-1252-05	CHIP R 0 OHM J 1/16W	
L218			L40-1078-94	SMALL FIXED INDUCTOR (10NH)		R54			RK73GB1J154J	CHIP R 150K J 1/16W	
L220			L34-1306-15	AIR-CORE COIL		R55			RK73GB1J104J	CHIP R 100K J 1/16W	
L221			L34-1317-05	AIR-CORE COIL		R56			RK73GB1J103J	CHIP R 10K J 1/16W	
L222,223			L34-1307-05	AIR-CORE COIL	TK-980	R57			RK73GB1J473J	CHIP R 47K J 1/16W	
L222,223			L34-1313-05	AIR-CORE COIL	TK-981	R58			RK73GB1J102J	CHIP R 1.0K J 1/16W	
L224			L34-1306-15	AIR-CORE COIL		R60			RK73GB1J472J	CHIP R 4.7K J 1/16W	
L225			L92-0179-05	CHIP FERRITE		R61			RK73GB1J103J	CHIP R 10K J 1/16W	
L226			L40-1078-94	SMALL FIXED INDUCTOR (10NH)		R62			RK73GB1J101J	CHIP R 100 J 1/16W	
L229			L34-1308-15	AIR-CORE COIL		R63-65			R92-1252-05	CHIP R 0 OHM J 1/16W	
L300			L40-1563-92	SMALL FIXED INDUCTOR (1.5NH)		R66			RK73GB1J682J	CHIP R 6.8K J 1/16W	
L301			L40-3963-92	SMALL FIXED INDUCTOR (3.9NH)	TK-981	R67			RK73GB1J470J	CHIP R 47 J 1/16W	
L301			L40-4763-92	SMALL FIXED INDUCTOR (4.7NH)	TK-980	R69			RK73GB1J102J	CHIP R 1.0K J 1/16W	
L303,304			L40-2763-92	SMALL FIXED INDUCTOR (2.7NH)		R70-73			R92-1252-05	CHIP R 0 OHM J 1/16W	
L305			L92-0179-05	CHIP FERRITE		R74			RK73GB1J473J	CHIP R 47K J 1/16W	
L310-312			L40-8265-92	SMALL FIXED INDUCTOR (8.2NH)		R75			RK73GB1J102J	CHIP R 1.0K J 1/16W	
X1			L77-1882-05	VCXO (16.8MHZ)		R76			RK73GB1J153J	CHIP R 15K J 1/16W	
X2			L77-1762-05	CRYSTAL RESONATOR (44.395MHZ)		R77			RK73GB1J333J	CHIP R 33K J 1/16W	
XF1			L71-0525-05	MCF (5KHZ)	TK-980	R78			RK73GB1J104J	CHIP R 100K J 1/16W	
XF1			L71-0583-05	MCF (3.75KHZ)	TK-981	R79			RK73GB1J180J	CHIP R 18 J 1/16W	TK-981
R1			RK73GB1J102J	CHIP R 1.0K J 1/16W		R79			RK73GB1J390J	CHIP R 39 J 1/16W	TK-980
R2			R92-1252-05	CHIP R 0 OHM J 1/16W		R80			RK73GB1J473J	CHIP R 47K J 1/16W	
R3			RK73GB1J101J	CHIP R 100 J 1/16W		R82,83			RK73GB1J151J	CHIP R 150 J 1/16W	TK-980
R4			RK73GB1J102J	CHIP R 1.0K J 1/16W		R82,83			RK73GB1J271J	CHIP R 270 J 1/16W	TK-981
R6,7			R92-1252-05	CHIP R 0 OHM J 1/16W		R85			RK73GB1J821J	CHIP R 820 J 1/16W	
R8			RK73GB1J102J	CHIP R 1.0K J 1/16W		R86,87			R92-1252-05	CHIP R 0 OHM J 1/16W	
R9			R92-1252-05	CHIP R 0 OHM J 1/16W		R88			RK73EB2B181J	CHIP R 180 J 1/8W	
R10,11			RK73GB1J102J	CHIP R 1.0K J 1/16W		R89			RK73EB2B151J	CHIP R 150 J 1/8W	
R12			R92-1252-05	CHIP R 0 OHM J 1/16W		R90			RK73GB1J2R2J	CHIP R 2.2 J 1/16W	
R14			RK73GB1J473J	CHIP R 47K J 1/16W		R91			RK73GB1J472J	CHIP R 4.7K J 1/16W	
R15			RK73GB1J103J	CHIP R 10K J 1/16W		R92			RK73FB2A472J	CHIP R 4.7K J 1/10W	
R16			RK73GB1J274J	CHIP R 270K J 1/16W		R93			RK73FB2A470J	CHIP R 47 J 1/10W	
R17			R92-1252-05	CHIP R 0 OHM J 1/16W		R94			R92-1252-05	CHIP R 0 OHM J 1/16W	
R19			RK73GB1J153J	CHIP R 15K J 1/16W		R95			RK73FB2A154J	CHIP R 150K J 1/10W	
R20			RK73GB1J104J	CHIP R 100K J 1/16W		R96			RK73GB1J181J	CHIP R 180 J 1/16W	TK-981
R21			RK73GB1J563J	CHIP R 56K J 1/16W		R96			RK73GB1J331J	CHIP R 330 J 1/16W	TK-980
R22			RK73GB1J104J	CHIP R 100K J 1/16W		R97,98			RK73GB1J473J	CHIP R 47K J 1/16W	
R23			RK73GB1J224J	CHIP R 220K J 1/16W		R99			RK73GB1J152J	CHIP R 1.5K J 1/16W	
R25			RK73GB1J394J	CHIP R 390K J 1/16W		R100			RK73GB1J151J	CHIP R 150 J 1/16W	TK-981
R26			RK73GB1J104J	CHIP R 100K J 1/16W		R100			RK73GB1J331J	CHIP R 330 J 1/16W	TK-980

PARTS LIST

TX-RX UNIT (X57-6520-XX)

Ref. No.	Address	New parts	Parts No.	Description	Desti-nation	Ref. No.	Address	New parts	Parts No.	Description	Desti-nation
R101			RK73FB2A470J	CHIP R 47 J 1/10W		R236			RK73GB1J470J	CHIP R 47 J 1/16W	
R102			RK73FB2A102J	CHIP R 1.0K J 1/10W		R237			RK73GB1J153J	CHIP R 15K J 1/16W	
R103			RK73FB2A223J	CHIP R 22K J 1/10W		R239			RK73GB1J154J	CHIP R 150K J 1/16W	
R104			RK73FB2A473J	CHIP R 47K J 1/10W		R240			RK73GB1J333J	CHIP R 33K J 1/16W	
R105			R92-2538-05	RN 3.9K B 1/8W		R247			R92-1273-05	CHIP C 39 J 1/2W	
R106			R92-1252-05	CHIP R 0 OHM J 1/16W		R248,249			R92-1214-05	CHIP R 120 J 1/2W	TK-980
R107			RK73GB1J473J	CHIP R 47K J 1/16W		R248,249			R92-1261-05	CHIP R 150 J 1/2W	TK-981
R109			R92-0670-05	CHIP R 0 OHM		R250			RK73GB1J470J	CHIP R 47 J 1/16W	
R110			RK73GB1J470J	CHIP R 47 J 1/16W		R251			RK73GB1J474J	CHIP R 470K J 1/16W	
R111			RK73GB1J472J	CHIP R 4.7K J 1/16W		R252			R92-1217-05	CHIP R 0 OHM	
R112,113			R92-1268-05	RN 4.7K B 1/8W		R253,254			RK73GB1J821J	CHIP R 820 J 1/16W	
R116			RK73GB1J473J	CHIP R 47K J 1/16W	TK-980	R255,256			R92-1308-05	CHIP R 22 J 1W	
R118			RK73GB1J392J	CHIP R 3.9K J 1/16W		R257,258			R92-0670-05	CHIP R 0 OHM	
R119			RK73GB1J103J	CHIP R 10K J 1/16W		R260			RK73FB2A153J	CHIP R 15K J 1/10W	
R120			R92-1268-05	RN 4.7K B 1/8W		R261			RK73FB2A182J	CHIP R 1.8K J 1/10W	
R121			RK73GB1J472J	CHIP R 4.7K J 1/16W		R301-303			RK73GB1J102J	CHIP R 1.0K J 1/16W	
R122			RK73FB2A272J	CHIP R 2.7K J 1/10W		R305			RK73GB1J103J	CHIP R 10K J 1/16W	
R124			RK73GB1J223J	CHIP R 22K J 1/16W		R306			RK73GB1J102J	CHIP R 1.0K J 1/16W	TK-980
R127		*	R92-2682-05	CHIP R 2.0K B 1/16W		R306			RK73GB1J471J	CHIP R 470 J 1/16W	TK-981
R128			RK73GB1J223J	CHIP R 22K J 1/16W		R307			R92-1252-05	CHIP R 0 OHM J 1/16W	
R129			RK73GB1J100J	CHIP R 10 J 1/16W		R308			RK73GB1J101J	CHIP R 100 J 1/16W	
R132			RK73GB1J104J	CHIP R 100K J 1/16W		R309			RK73GB1J154J	CHIP R 150K J 1/16W	TK-981
R134			RK73GB1J473J	CHIP R 47K J 1/16W		R309			RK73GB1J333J	CHIP R 33K J 1/16W	TK-980
R135			R92-1261-05	CHIP R 150 J 1/2W		R310			RK73GB1J103J	CHIP R 10K J 1/16W	TK-980
R137			RK73GB1J473J	CHIP R 47K J 1/16W		R310			RK73GB1J473J	CHIP R 47K J 1/16W	TK-981
R139			RK73GB1J102J	CHIP R 1.0K J 1/16W		R311			RK73GB1J561J	CHIP R 560 J 1/16W	
R140			R92-1252-05	CHIP R 0 OHM J 1/16W		R312			RK73GB1J472J	CHIP R 4.7K J 1/16W	
R141			RK73GB1J104J	CHIP R 100K J 1/16W		R313			RK73GB1J273J	CHIP R 27K J 1/16W	
R143			RK73GB1J102J	CHIP R 1.0K J 1/16W		R314			RK73GB1J103J	CHIP R 10K J 1/16W	TK-981
R144			RK73GB1J223J	CHIP R 22K J 1/16W		R314			RK73GB1J223J	CHIP R 22K J 1/16W	TK-980
R145			RK73GB1J104J	CHIP R 100K J 1/16W		R315			RK73GB1J473J	CHIP R 47K J 1/16W	
R146			R92-1215-05	CHIP R 470 J 1/2W		R316,317			R92-1252-05	CHIP R 0 OHM J 1/16W	
R148			RK73FB2A472J	CHIP R 4.7K J 1/10W		R318			RK73GB1J391J	CHIP R 390 J 1/16W	
R150			R92-0670-05	CHIP R 0 OHM		R319			RK73GB1J102J	CHIP R 1.0K J 1/16W	
R151-153			R92-1252-05	CHIP R 0 OHM J 1/16W		R320			R92-1252-05	CHIP R 0 OHM J 1/16W	
R154			RK73GB1J103J	CHIP R 10K J 1/16W		R321			RK73GB1J470J	CHIP R 47 J 1/16W	
R155			RK73GB1J333J	CHIP R 33K J 1/16W		R322			RK73GB1J100J	CHIP R 10 J 1/16W	
R156			RK73GB1J471J	CHIP R 470 J 1/16W		R323			RK73GB1J470J	CHIP R 47 J 1/16W	TK-980
R157			RK73GB1J101J	CHIP R 100 J 1/16W		R323			RK73GB1J680J	CHIP R 68 J 1/16W	TK-981
R158,159			R92-1252-05	CHIP R 0 OHM J 1/16W		R408			R92-1252-05	CHIP R 0 OHM J 1/16W	
R160			RK73GB1J184J	CHIP R 180K J 1/16W		R411			R92-1252-05	CHIP R 0 OHM J 1/16W	
R163			RK73GB1J104J	CHIP R 100K J 1/16W		R414			R92-1252-05	CHIP R 0 OHM J 1/16W	
R166			R92-1252-05	CHIP R 0 OHM J 1/16W		D1-6			DA204U	DIODE	
R168			R92-1252-05	CHIP R 0 OHM J 1/16W		D7			02DZ20(Y,Z)	ZENER DIODE	
R170,171			R92-1252-05	CHIP R 0 OHM J 1/16W		D11			DAN202U	DIODE	
R172			RK73GB1J221J	CHIP R 220 J 1/16W		D16			1SS355	DIODE	
R176			R92-0670-05	CHIP R 0 OHM		D17			DA204U	DIODE	
R181,182			R92-0679-05	CHIP R 0 OHM		D18,19			HVC131	DIODE	
R183		*	R92-2682-05	CHIP R 2.0K B 1/16W		D20			1SS355	DIODE	
R209			RK73GB1J103J	CHIP R 10K J 1/16W		D21			02DZ5.6(X,Y)	ZENER DIODE	
R210			RK73GB1J473J	CHIP R 47K J 1/16W		D24			MINISMDC075-02	VARIATOR	
R211			RK73GB1J101J	CHIP R 100 J 1/16W		D26			1SS355	DIODE	
R212			RK73GB1J5R6J	CHIP R 5.6 J 1/16W		D28			02DZ15(X,Y)	ZENER DIODE	
R214			RK73GB1J221J	CHIP R 220 J 1/16W		D31			1SS355	DIODE	
R217			RK73GB1J101J	CHIP R 100 J 1/16W		D32			22ZR-10D	SURGE ABSORBER	
R218			RK73GB1J473J	CHIP R 47K J 1/16W		D34			02DZ18(X,Y)	ZENER DIODE	
R219			RK73GB1J273J	CHIP R 27K J 1/16W		D35			MA742	DIODE	
R220			RK73GB1J473J	CHIP R 47K J 1/16W		D37			DSA3A1	DIODE	
R221			RK73GB1J153J	CHIP R 15K J 1/16W		D38			02DZ5.1(Y)	ZENER DIODE	
R223			RK73GB1J102J	CHIP R 1.0K J 1/16W							

TK-980/981

PARTS LIST

TX-RX UNIT (X57-6520-XX)
PLL/VCO (X58-4530-XX)

Ref. No.	Address	New parts	Parts No.	Description	Destination
D200			HSM88AS	DIODE	
D208			MA4PH633	DIODE	
D209,210			XB15A709	DIODE	
IC1			TA75W01FU	MOS-IC	
IC2			TC75W51FU	MOS-IC	
IC3			TA75W558FU	MOS-IC	
IC4			TC4S66F	MOS-IC	
IC5			M62363FP	MOS-IC	
IC6			TA75W558FU	MOS-IC	
IC7,8			BU4094BCFV	MOS-IC	
IC9			TA78L05F	MOS-IC	
IC10			LA4422	BI-POLAR IC	
IC11			TA31136FN	MOS-IC	
IC12			TA78L05F	MOS-IC	
IC13			NJM2904E	MOS-IC	
IC14			TA7808S	MOS-IC	
IC15			TC4013BF(N)	MOS-IC	
IC16			NJM78L08UA	BI-POLAR IC	
IC300			CD8468	MOS-IC	
IC300			SA7025DK	MOS-IC	
IC400		*	RA20H8087M	MOS-IC	TK-980
IC400		*	RA20H8994M	MOS-IC	TK-981
Q1			2SK1824	FET	
Q2			2SC2412K(S)	TRANSISTOR	
Q4			DTD114EK	DIGITAL TRANSISTOR	
Q5,6			DTC114EE	DIGITAL TRANSISTOR	
Q7			2SC4226(R24)	TRANSISTOR	
Q8			DTC363EU	DIGITAL TRANSISTOR	
Q9			DTA114YUA	DIGITAL TRANSISTOR	
Q10			DTC114EE	DIGITAL TRANSISTOR	
Q11			2SA1362(Y)	TRANSISTOR	
Q12			2SB1132(Q,R)	TRANSISTOR	
Q13			DTC114EE	DIGITAL TRANSISTOR	
Q15			2SC2059K(P)	TRANSISTOR	
Q17			2SC4116(GR)	TRANSISTOR	
Q18			2SK1824	FET	
Q19			2SB1370(E,F)	TRANSISTOR	
Q20			DTA144EUA	DIGITAL TRANSISTOR	
Q21			DTC144EUA	DIGITAL TRANSISTOR	
Q22			DTC114EE	DIGITAL TRANSISTOR	
Q25,26			DTA114EE	DIGITAL TRANSISTOR	
Q27			2SA1641(S,T)	TRANSISTOR	
Q28			DTC114EE	DIGITAL TRANSISTOR	
Q30			DTA114EE	DIGITAL TRANSISTOR	
Q31			DTC114EE	DIGITAL TRANSISTOR	
Q32			2SK1824	FET	
Q33			DTC144EE	DIGITAL TRANSISTOR	
Q34			2SC2712(GR)	TRANSISTOR	
Q201			2SC4094(R37)	TRANSISTOR	
Q202			2SC3356(R24)	TRANSISTOR	
Q203			3SK255	FET	
Q204			2SK2596	FET	
Q205			DTC144EE	DIGITAL TRANSISTOR	
Q300			2SC4226(R24)	TRANSISTOR	
Q301,302			2SC3722K(S)	TRANSISTOR	
TH1			157-104-55001	THERMISTOR	
A1			X58-4530-10	SUB UNIT	TK-980
A1			X58-4530-11	SUB UNIT	TK-981

Ref. No.	Address	New parts	Parts No.	Description	Destination
PLL/VCO (X58-453X-XX) 0-10 : TK-980 0-11 : TK-981					
C100			CK73GB1H471K	CHIP C 470PF K	
C101			CC73GCH1H080B	CHIP C 8.0PF B	TK-980
C101			CC73GCH1H4R5B	CHIP C 4.5PF B	TK-981
C102			CC73GCH1HR75C	CHIP C 0.75PF C	
C103			CK73GB1H471K	CHIP C 470PF K	
C104			CC73GCH1H010B	CHIP C 1.0PF B	TK-981
C104			CC73GCH1H1R5B	CHIP C 1.5PF B	TK-980
C105			CC73GCH1H040B	CHIP C 4.0PF B	TK-981
C105			CC73GCH1H060B	CHIP C 6.0PF B	TK-980
C106,107			CC73GCH1HR75B	CHIP C 0.75PF B	
C108			CK73GB1H102K	CHIP C 1000PF K	
C109			CC73GCH1H030B	CHIP C 3.0PF B	
C110			CC73GCH1H050B	CHIP C 5.0PF B	
C111			CC73GCH1H470J	CHIP C 47PF J	
C112			CK73GB1H471K	CHIP C 470PF K	
C113			CC73GCH1H040B	CHIP C 4.0PF B	TK-980
C113			CC73GCH1H050B	CHIP C 5.0PF B	TK-981
C114			CK73GB1H102K	CHIP C 1000PF K	TK-980
C114			CK73GB1H471K	CHIP C 470PF K	TK-981
C115			CC73GCH1H030B	CHIP C 3.0PF B	
C116			CC73GCH1H060B	CHIP C 6.0PF B	
C117			CK73GB1H102K	CHIP C 1000PF K	
C118			CC73GCH1HR75B	CHIP C 0.75PF B	
TC100			C05-0384-05	CERAMIC TRIMMER (10PF)	
CN100			E40-5699-05	PIN ASSY	
			F10-2279-04	SHIELDING CASE	
L100,101			L40-1595-34	SMALL FIXED INDUCTOR (1.5UH)	
L102			L40-1071-35	SMALL FIXED INDUCTOR (10NH)	TK-981
L102			L40-1271-35	SMALL FIXED INDUCTOR (12NH)	TK-980
L103			L34-4518-05	AIR-CORE COIL	
L104			L40-1098-76	SMALL FIXED INDUCTOR (1UH)	
L105			L40-1871-35	SMALL FIXED INDUCTOR (18NH)	TK-981
L105			L40-3971-35	SMALL FIXED INDUCTOR (39NH)	TK-980
L106			L40-1571-35	SMALL FIXED INDUCTOR (15NH)	TK-981
L106			L40-2771-35	SMALL FIXED INDUCTOR (27NH)	TK-980
L107			L40-1595-34	SMALL FIXED INDUCTOR (1.5UH)	
R100,101			R92-1252-05	CHIP R 0 OHM J 1/16W	
R102			RK73GB1J102J	CHIP R 1.0K J 1/16W	
R103			R92-1252-05	CHIP R 0 OHM J 1/16W	
R104			RK73GB1J101J	CHIP R 100 J 1/16W	
R105			RK73GB1J823J	CHIP R 82K J 1/16W	
R106			RK73GB1J154J	CHIP R 150K J 1/16W	
R107			RK73GB1J270J	CHIP R 27 J 1/16W	
R108,109			RK73GB1J101J	CHIP R 100 J 1/16W	
R110			RK73GB1J181J	CHIP R 180 J 1/16W	TK-981
R110			RK73GB1J221J	CHIP R 220 J 1/16W	TK-980
R111			RK73GB1J223J	CHIP R 22K J 1/16W	
R112			RK73GB1J103J	CHIP R 10K J 1/16W	
R113			RK73GB1J470J	CHIP R 47 J 1/16W	
R114			R92-1252-05	CHIP R 0 OHM J 1/16W	
D100,101			1SV283	VARIABLE CAPACITANCE DIODE	
D102			1SV214	VARIABLE CAPACITANCE DIODE	
Q100			2SC4226(R24)	TRANSISTOR	
Q101			2SK508NV(K52)	FET	
Q102			2SC4226(R24)	TRANSISTOR	

PC BOARD TK-980/981

PLL/VCO (X58-453X-XX) 0-10 : TK-980 0-11 : TK-981
 Component side view (J72-0608-02)

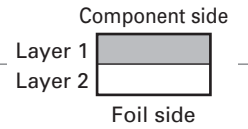
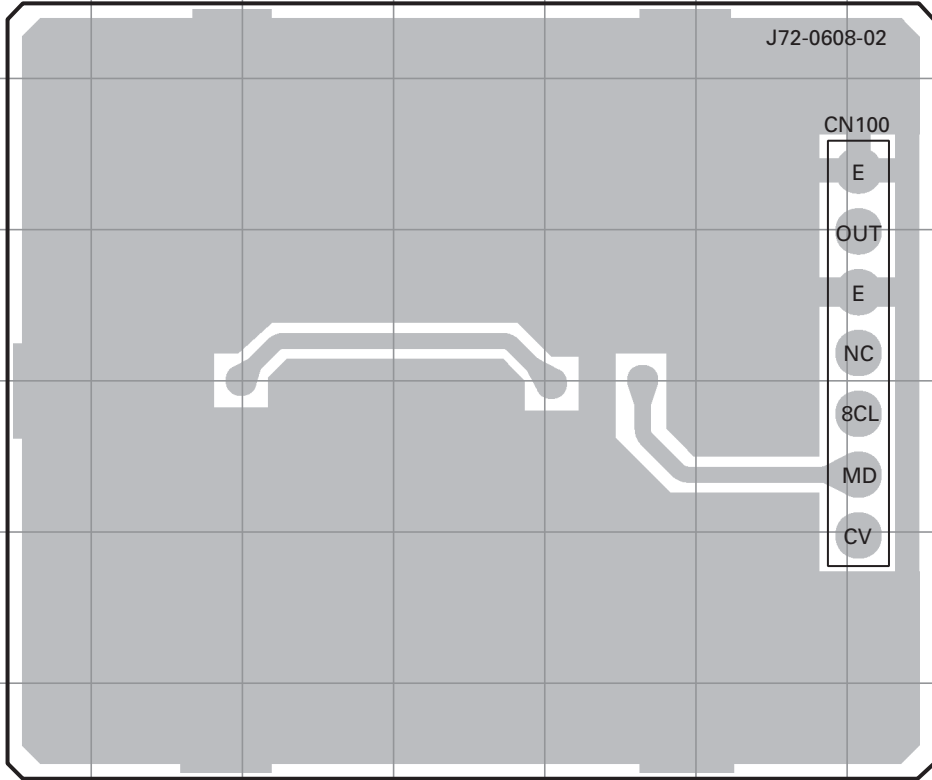

PLL/VCO (X58-453X-XX) 0-10 : TK-980 0-11 : TK-981
 Foil side view (J72-0608-02)

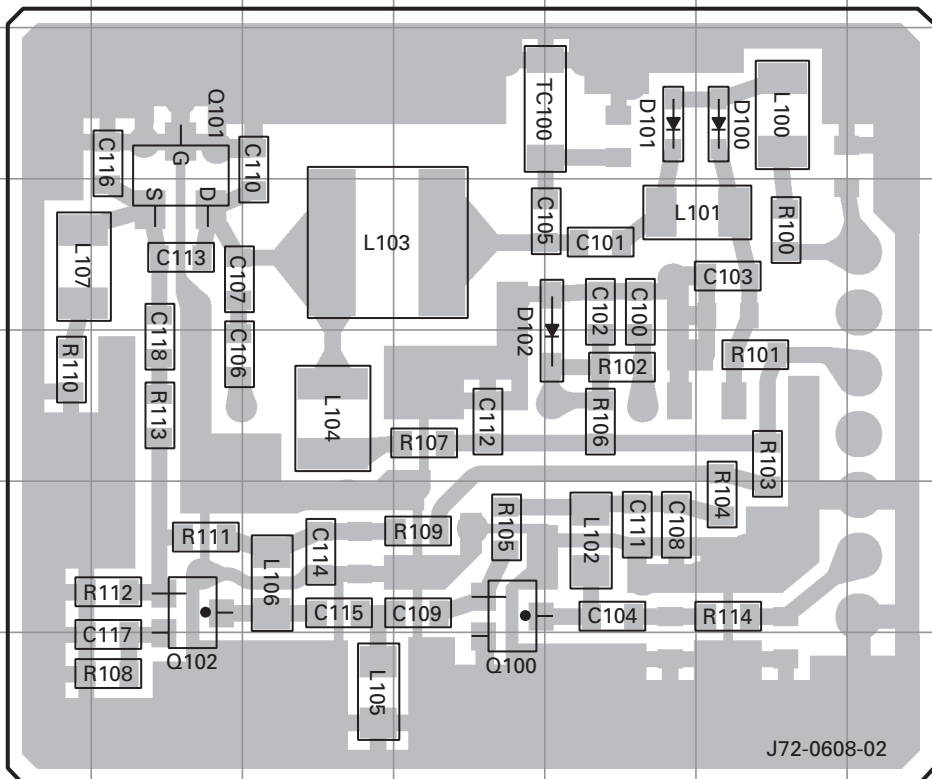

Ref. No.	Address
Q100	12E
Q101	9C
Q102	12C
D100	9G
D101	9F
D102	11F

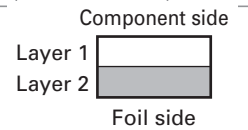

TK-980/981 PC BOARD

TX-RX UNIT (X57-652X-XX) (A/2)
0-10 : TK-980 0-11 : TK-981
Component side view
(J72-0816-19/29 A/2)

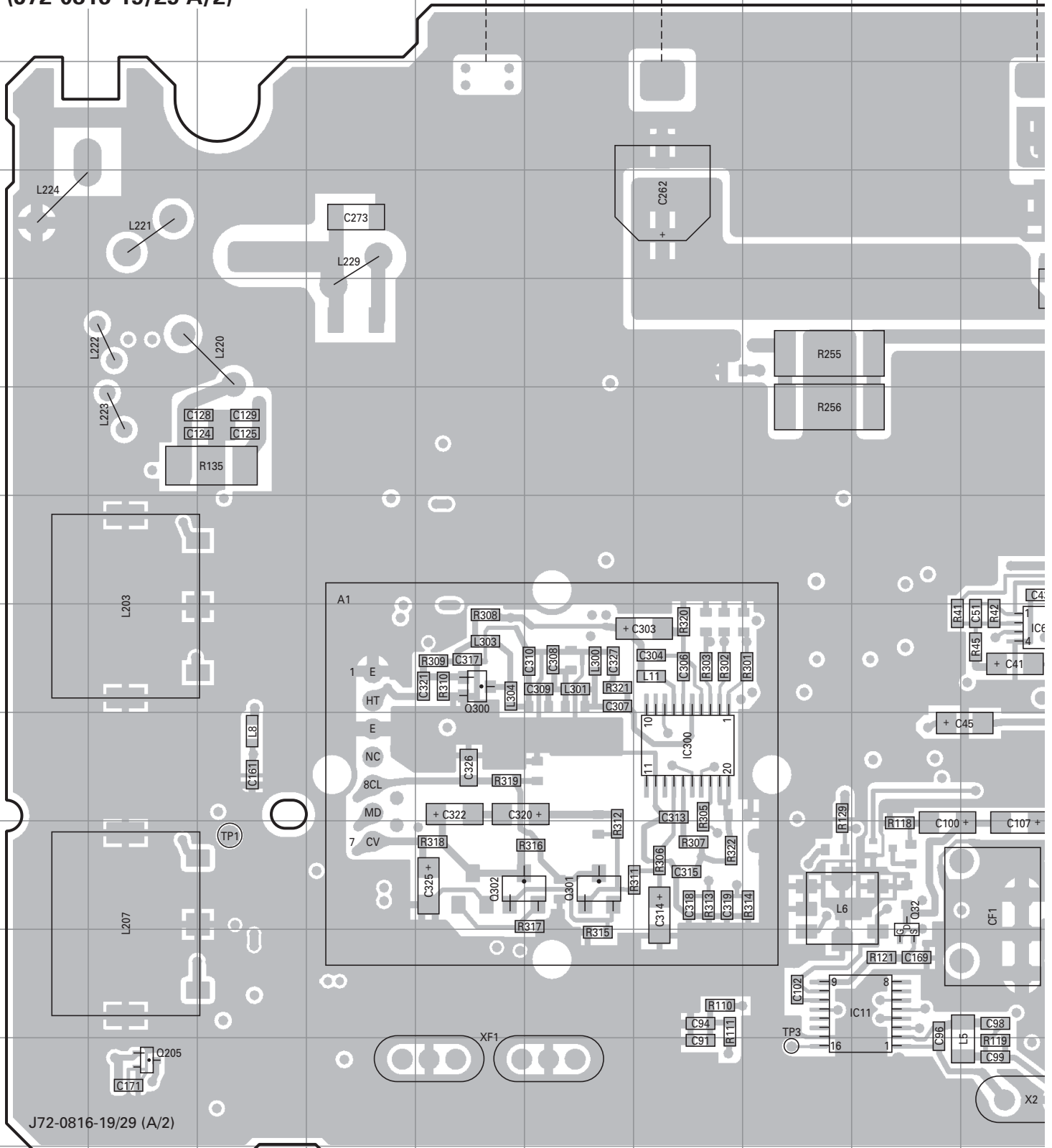

J72-0816-19/29 (A/2)

PC BOARD TK-980/981

Note : The circuit pattern of J72-0816-19 and J72-0816-29 is the same.

TX-RX UNIT (X57-652X-XX) (A/2)

0-10 : TK-980 0-11 : TK-981

Component side view (J72-0816-19/29 A/2)

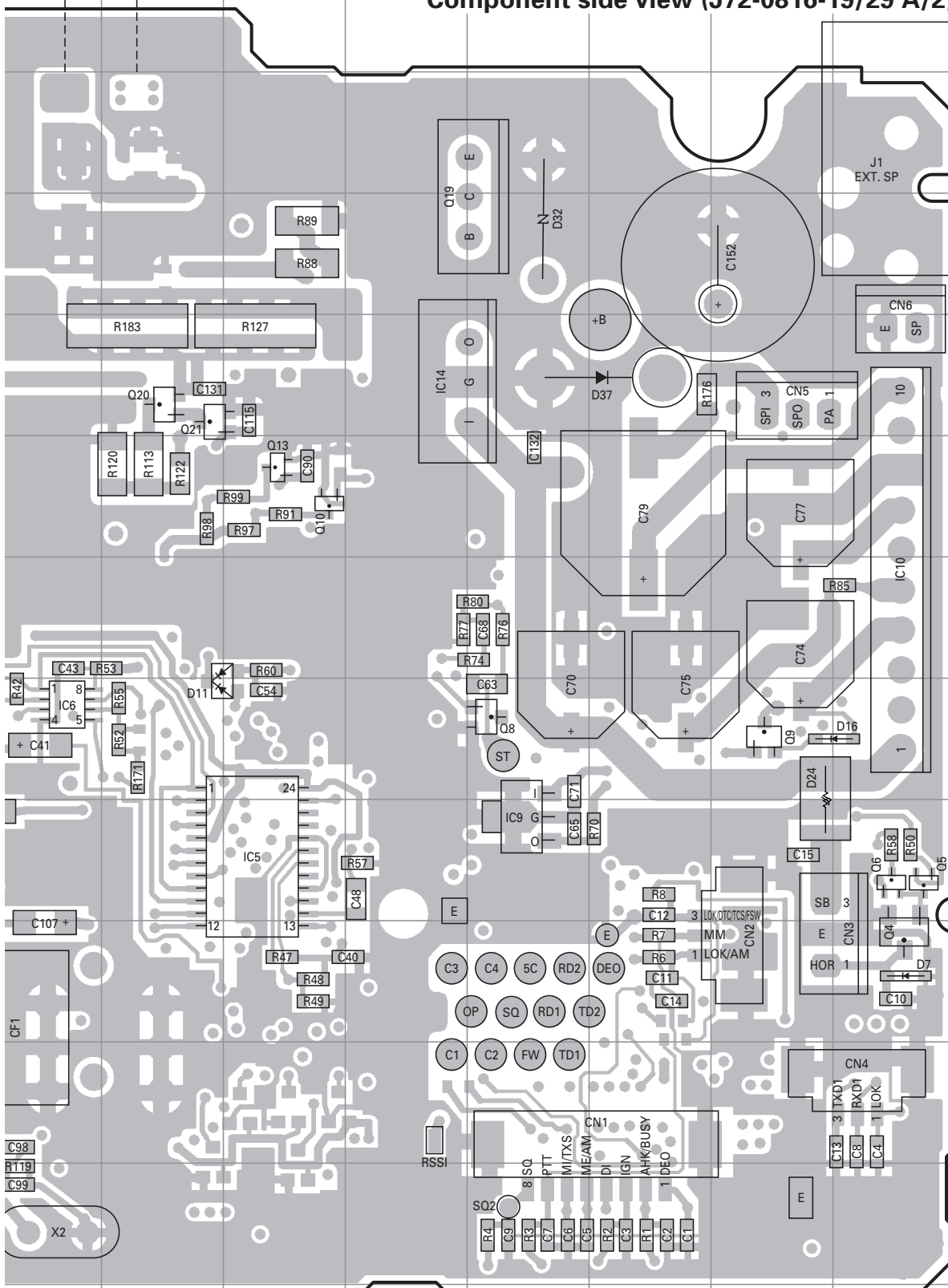

Ref. No.	Address
IC5	10L
IC6	9J
IC9	10N
IC10	8Q
IC11	12I
IC14	6M
IC300	10G
Q4	11Q
Q5	10Q
Q6	10Q
Q8	9N
Q9	9P
Q10	7L
Q13	7L
Q19	5N
Q20	6K
Q21	6K
Q32	11I
Q205	13B
Q300	9E
Q301	11F
Q302	11E
D7	11Q
D11	9K
D16	9Q
D24	9P
D32	5N
D37	6O

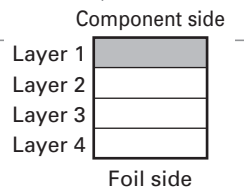

TK-980/981 PC BOARD

PC BOARD TK-980/981

Note : The circuit pattern of J72-0816-19 and J72-0816-29 is the same.

TX-RX UNIT (X57-652X-XX) (A/2)
 0-10 : TK-980 0-11 : TK-981
Component side view
(J72-0816-19/29 A/2)

TX-RX UNIT (X57-652X-XX) (A/2)
 0-10 : TK-980 0-11 : TK-981
Component side view (J72-0816-19/29 A/2)

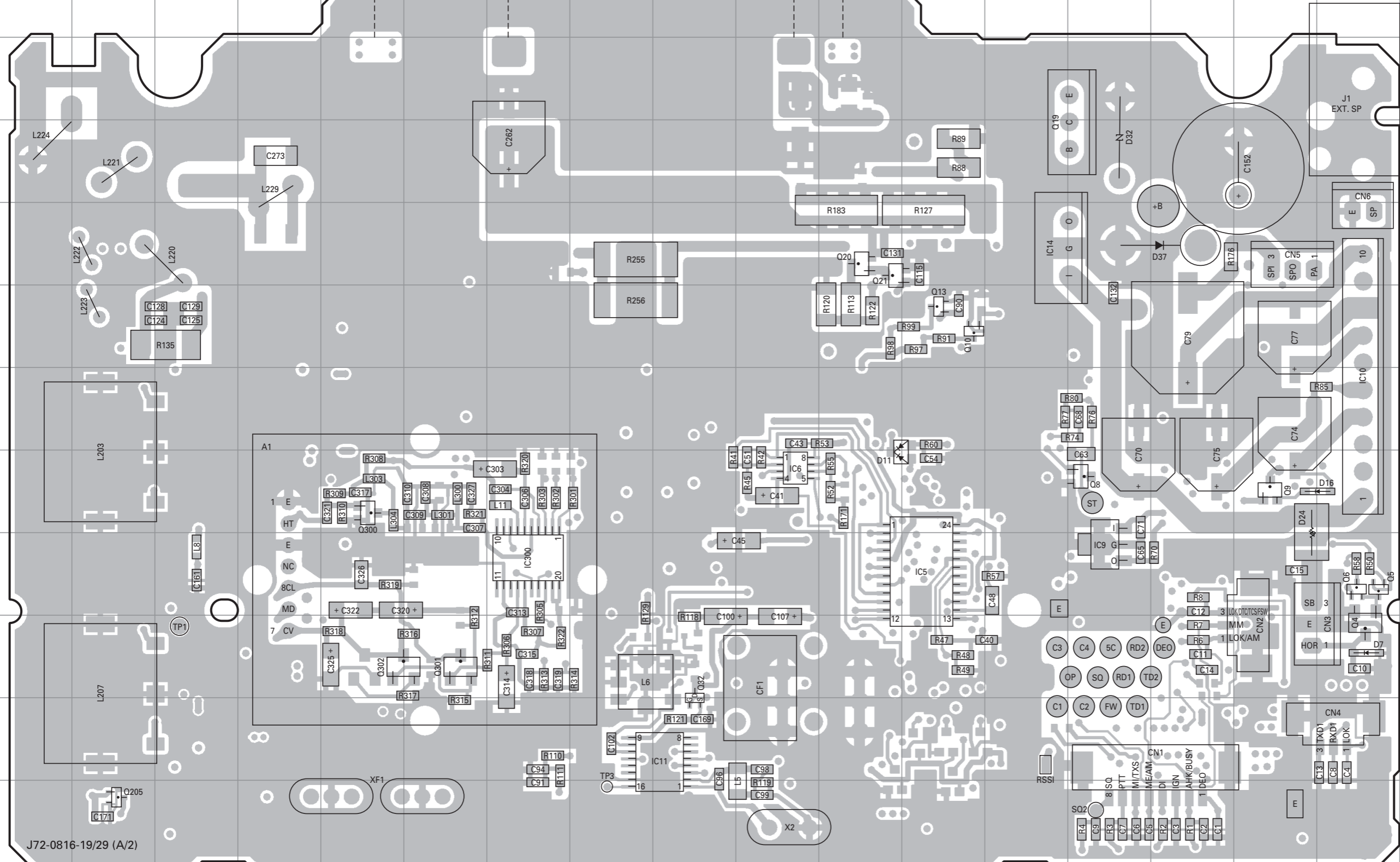

Ref. No.	Address
IC5	10L
IC6	9J
IC9	10N
IC10	8Q
IC11	12I
IC14	6M
IC300	10G
Q4	11Q
Q5	10Q
Q6	10Q
Q8	9N
Q9	9P
Q10	7L
Q13	7L
Q19	5N
Q20	6K
Q21	6K
Q32	11I
Q205	13B
Q300	9E
Q301	11F
Q302	11E
D7	11Q
D11	9K
D16	9Q
D24	9P
D32	5N
D37	6O

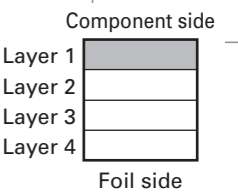

J72-0816-19/29 (A/2)

TK-980/981 PC BOARD

Note : The circuit pattern of J72-0816-19 and J72-0816-29 is the same.

TX-RX UNIT (X57-652X-XX) (A/2)

0-10 : TK-980 0-11 : TK-981

Foil side view (J72-0816-19/29 A/2)

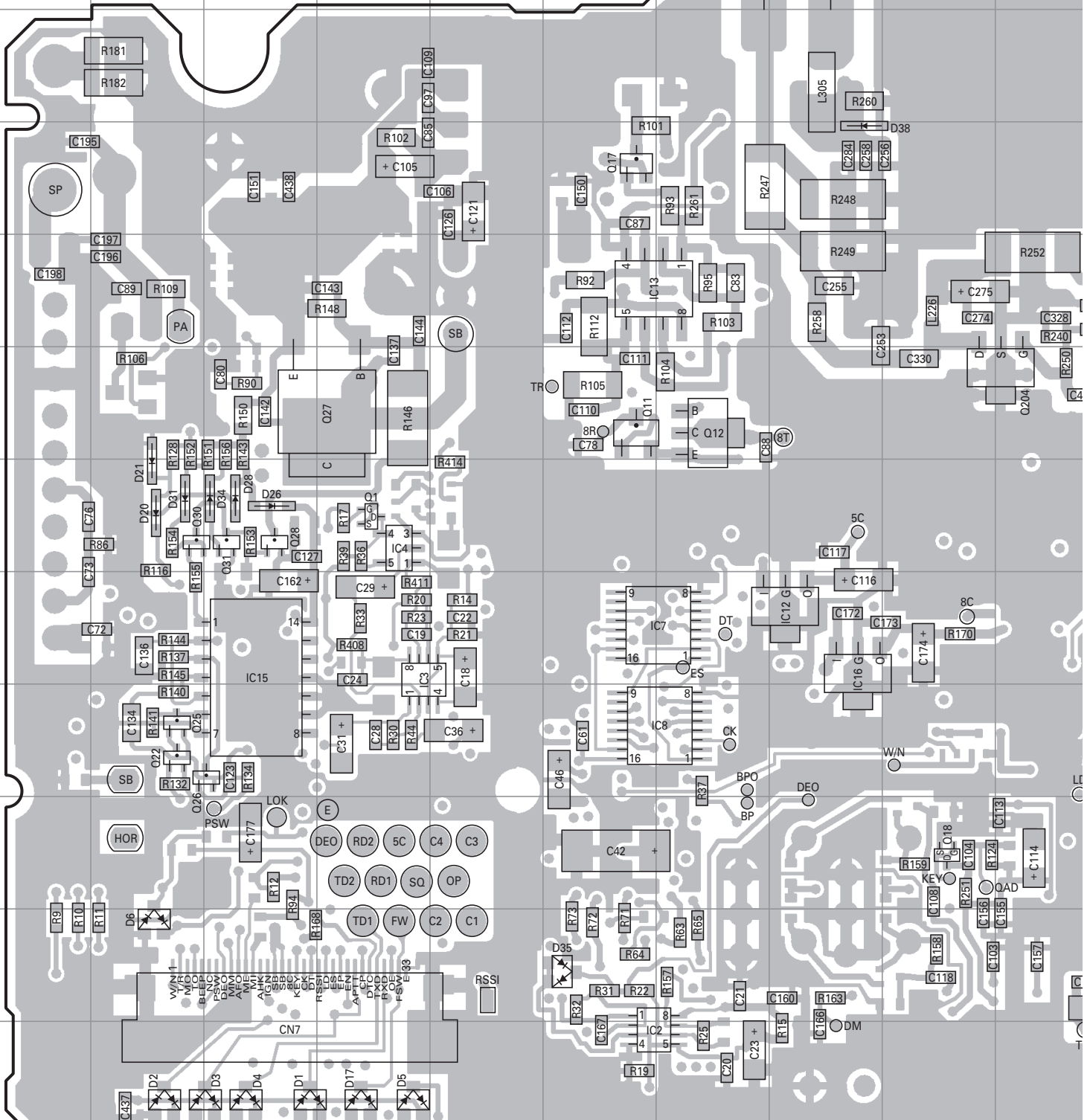

PC BOARD TK-980/981

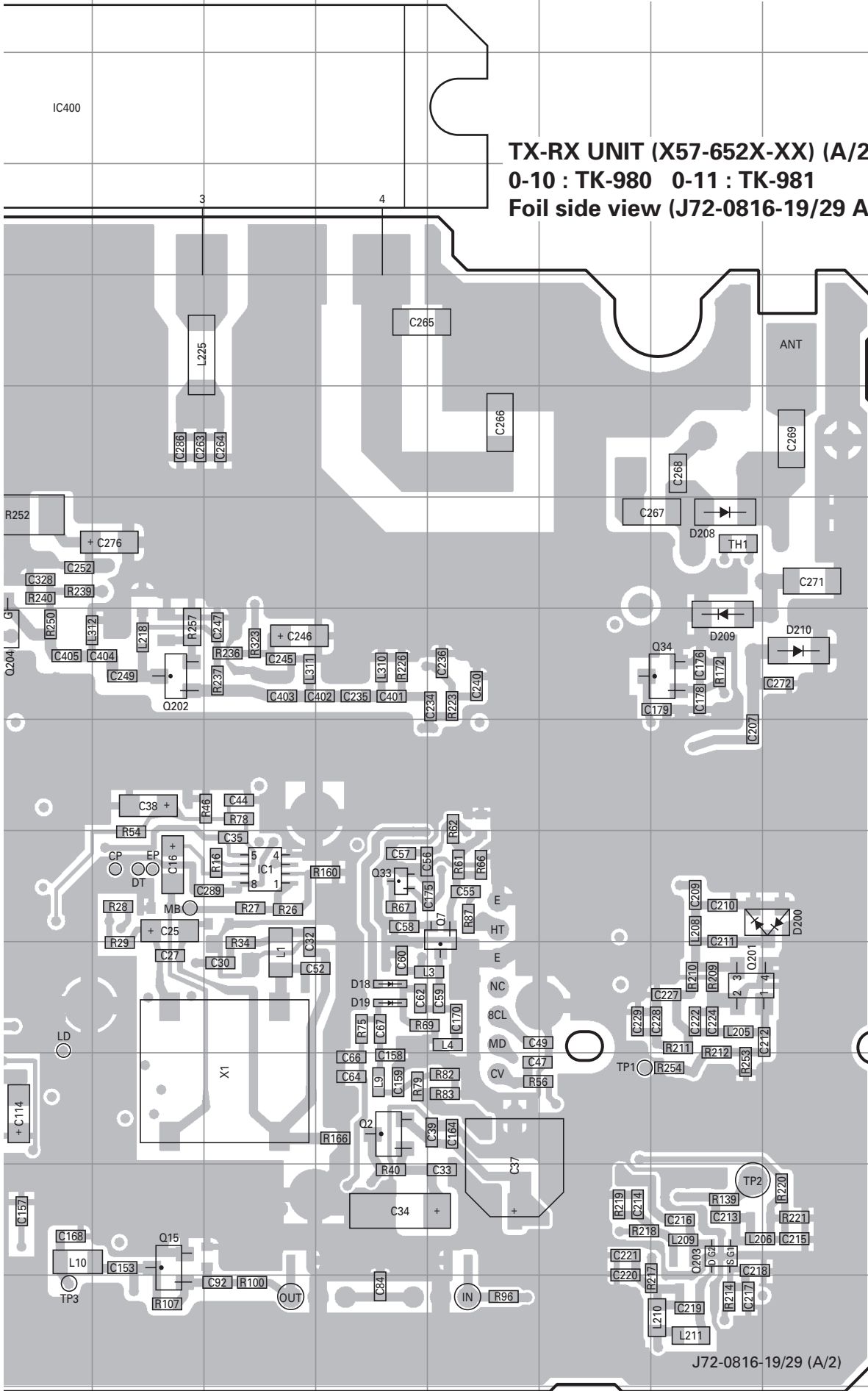

Ref. No.	Address
IC1	9L
IC2	13F
IC3	9D
IC4	8D
IC7	9G
IC8	10G
IC12	9H
IC13	6F
IC15	9C
IC16	9H
IC400	2J
Q1	8D
Q2	11M
Q7	9N
Q11	7F
Q12	7G
Q15	12K
Q17	5F
Q18	11I
Q22	10B
Q25	10B
Q26	10C
Q27	7D
Q28	8C
Q30	8B
Q31	8C
Q33	9M
Q34	7P
Q201	10P
Q202	7K
Q203	12P
Q204	7J
D1	13C
D2	13B
D3	13C
D4	13C
D5	13D
D6	12B
D17	13D
D18	10M
D19	10M
D20	8B
D21	8B
D26	8C
D28	8C
D31	8B
D34	8C
D35	12F
D38	5H
D200	9Q
D208	6P
D209	7P
D210	7Q

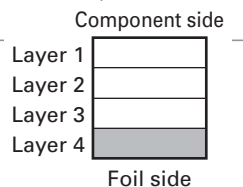

TK-980/981 PC BOARD

PC BOARD TK-980/981

Note : The circuit pattern of J72-0816-19 and J72-0816-29 is the same.

TX-RX UNIT (X57-652X-XX) (A/2)
 0-10 : TK-980 0-11 : TK-981
 Foil side view (J72-0816-19/29 A/2)

TX-RX UNIT (X57-652X-XX) (A/2)
 0-10 : TK-980 0-11 : TK-981
 Foil side view (J72-0816-19/29 A/2)

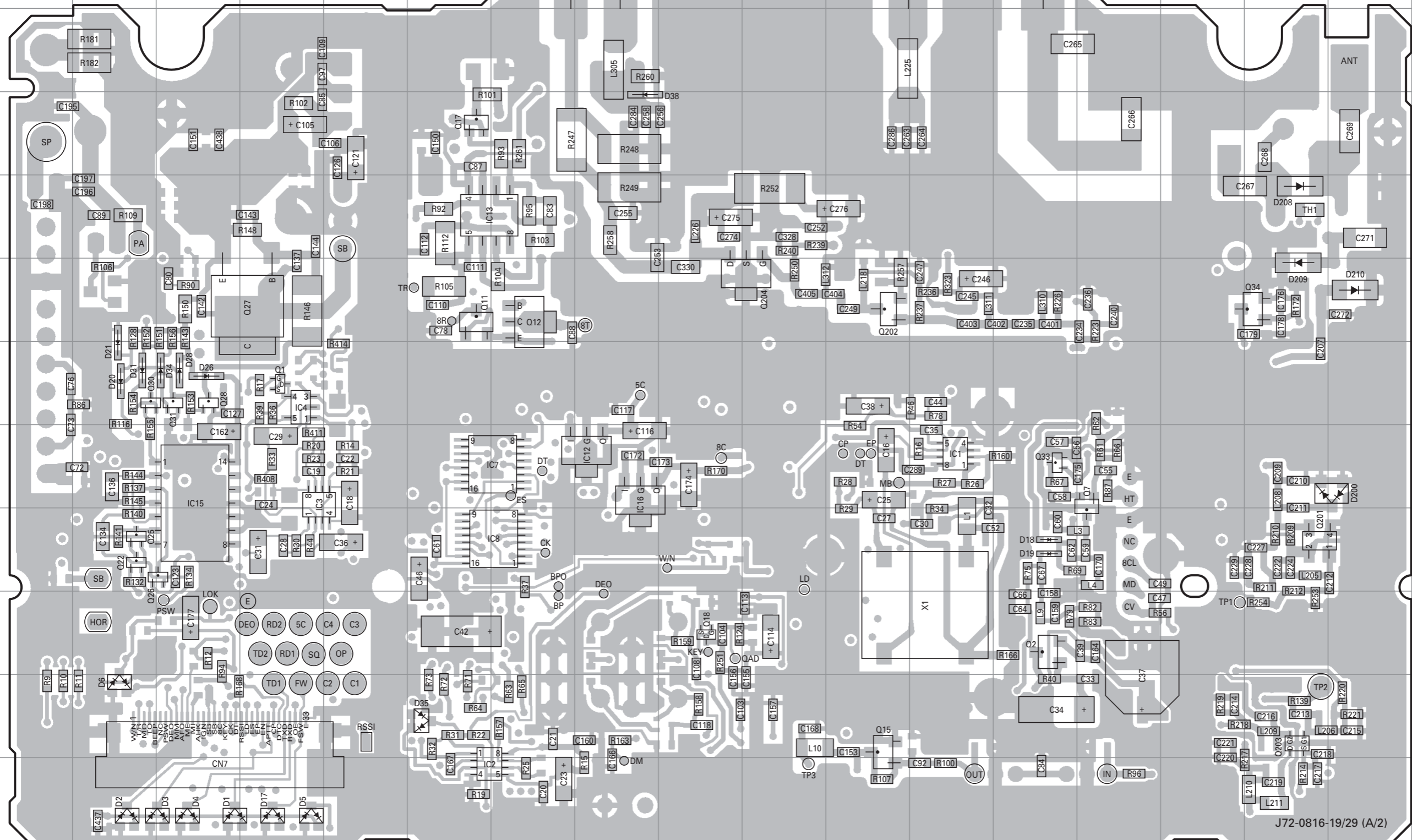

Ref. No.	Address
IC1	9L
IC2	13F
IC3	9D
IC4	8D
IC7	9G
IC8	10G
IC12	9H
IC13	6F
IC15	9C
IC16	9H
IC400	2J
Q1	8D
Q2	11M
Q7	9N
Q11	7F
Q12	7G
Q15	12K
Q17	5F
Q18	11I
Q22	10B
Q25	10B
Q26	10C
Q27	7D
Q28	8C
Q30	8B
Q31	8C
Q33	9M
Q34	7P
Q201	10P
Q202	7K
Q203	12P
Q204	7J
D1	13C
D2	13B
D3	13C
D4	13C
D5	13D
D6	12B
D17	13D
D18	10M
D19	10M
D20	8B
D21	8B
D26	8C
D28	8C
D31	8B
D34	8C
D35	12F
D38	5H
D200	9Q
D208	6P
D209	7P
D210	7Q

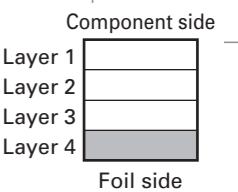

J72-0816-19/29 (A/2)

TK-980/981 SCHEMATIC DIAGRAM

X57-652X-XX (A/2) TX-RX UNIT

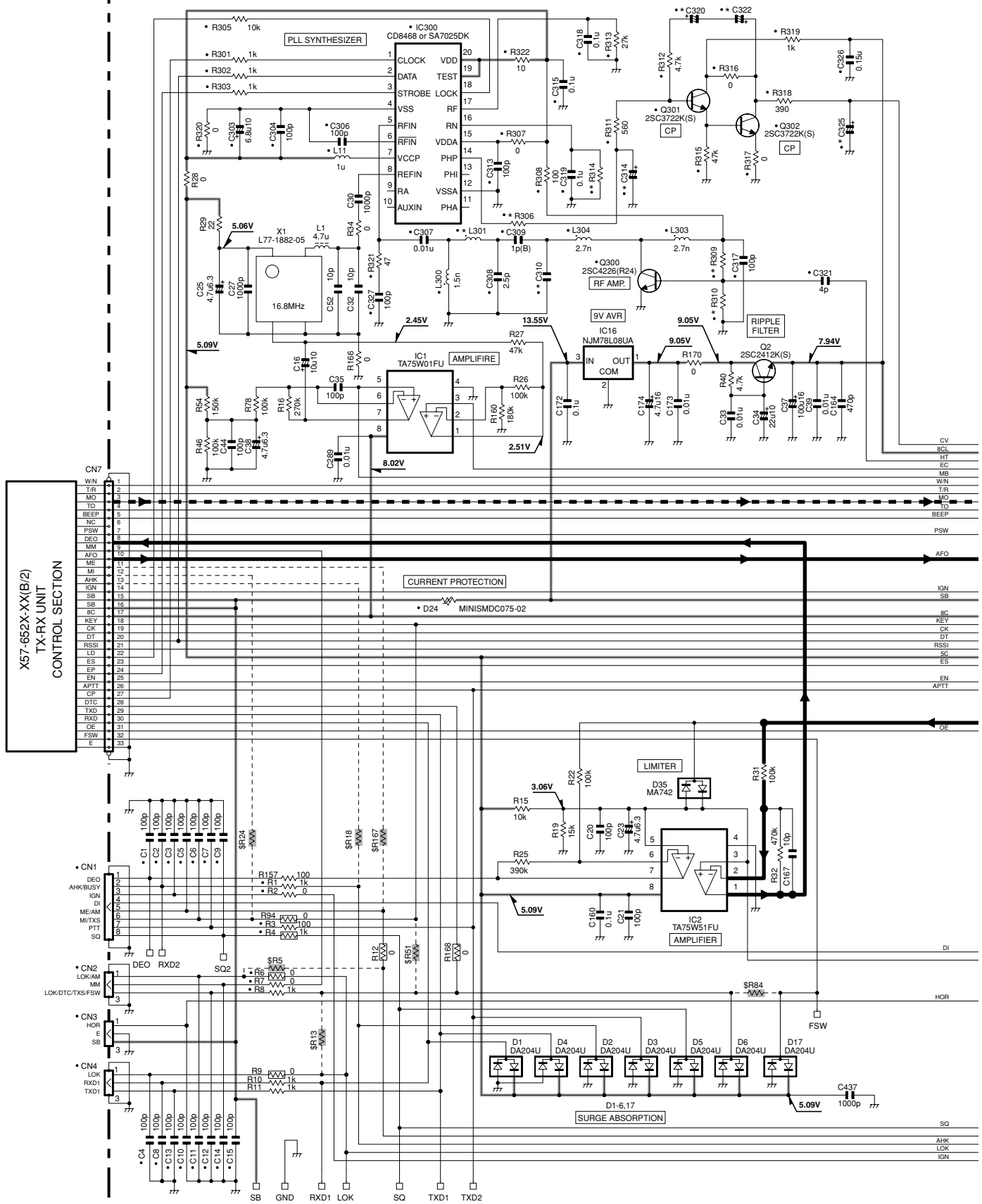

X57-652X-XX	L301	R306	R309	R310	R314	C310	C314	C320	C322	C325
0-10 TK-980	4.7n	1k	33k	10k	22k	2.5p	0.1u35	1u25	1u25	1u25
0-11 TK-981	3.9n	470	150k	47k	10k	1.5p	0.068u35	0.47u25	0.47u25	0.47u25

SCHEMATIC DIAGRAM TK-980/981

TX-RX UNIT (X57-652X-XX) (A/2)

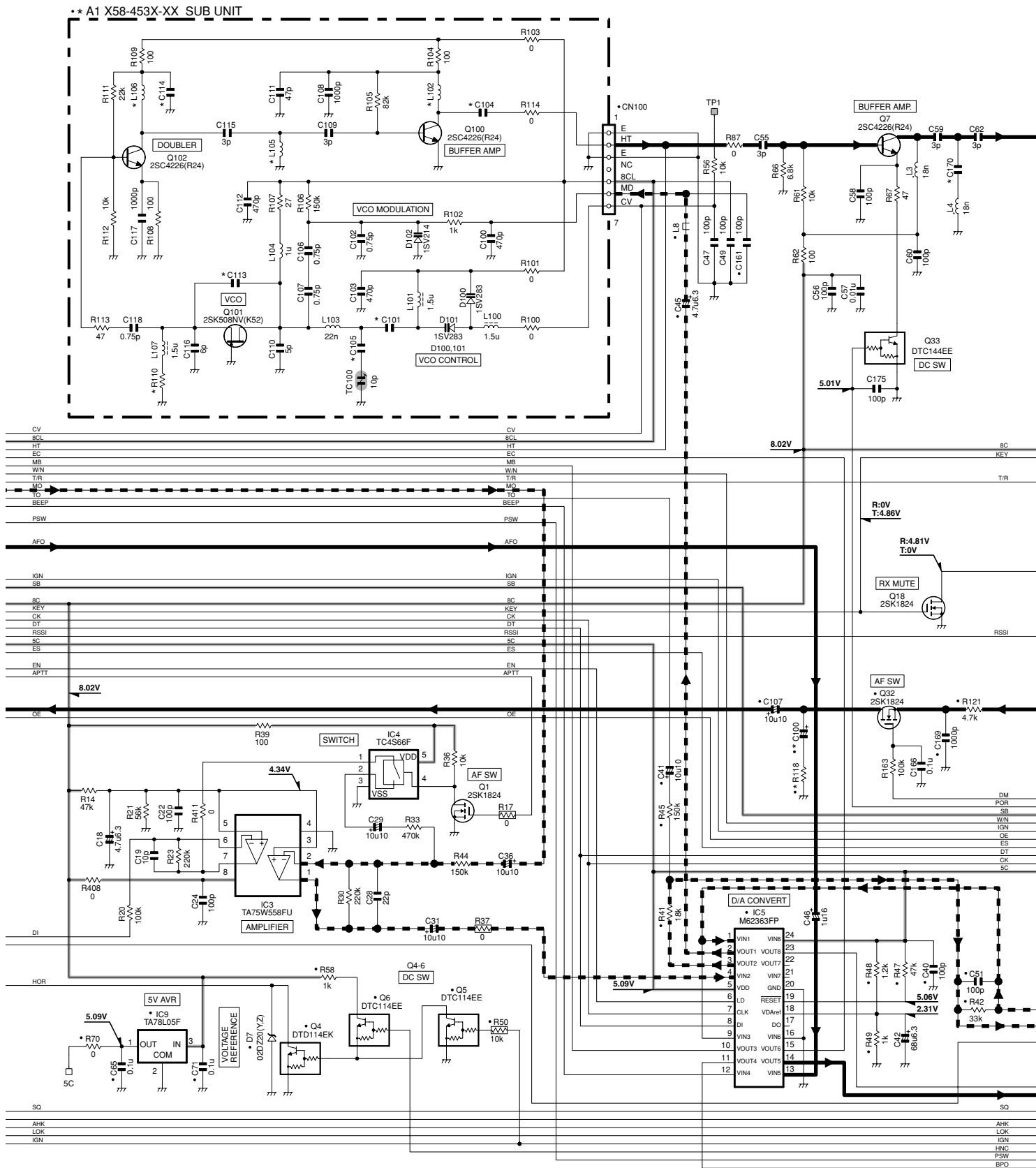

X58-453X-XX	C101	C104	C105	C113	C114	R110	L102	L105	L106
0-10 TK-980	8p	1.5p	6p	4p	1000p	220	12n	39n	27n
0-11 TK-981	4.5p	1P	5p	470p	180	10n	18n	15n	

X57-652X-XX	A1	R118	C100	C170
0-10 TK-980	X58-4530-10	3.9k	10u10	7p(B)
0-11 TK-981	X58-4530-11	NO	NO	5p

TK-980/981 SCHEMATIC DIAGRAM

TX-RX UNIT (X57-652X-XX) (A/2)

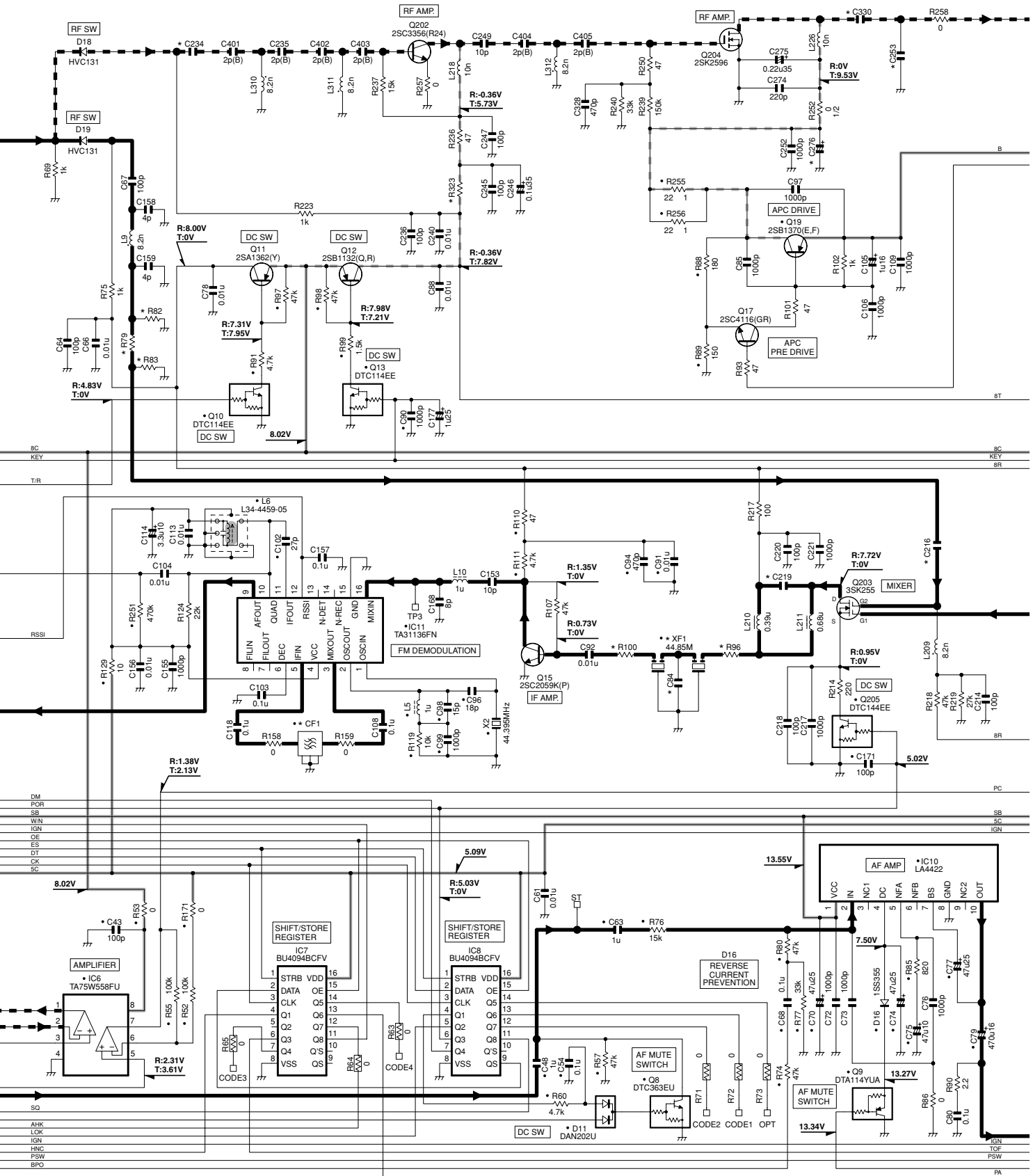

X57-652X-XX	XF1	CF1	R79	R82	R83	R96	R100	R323	C84	C216	C219	C234	C253	C276	C330	
0-10	TK-980	L71-0525-05	L72-0998-05	39	150	150	330	330	47	12p	1.5p(B)	11p	15p	6p	4.7u20	15p
0-11	TK-981	L71-0583-05	L72-0986-05	18	270	270	180	150	68	22p	1p(B)	12p	100p	8p	2.2u20	47p

SCHEMATIC DIAGRAM TK-980/981

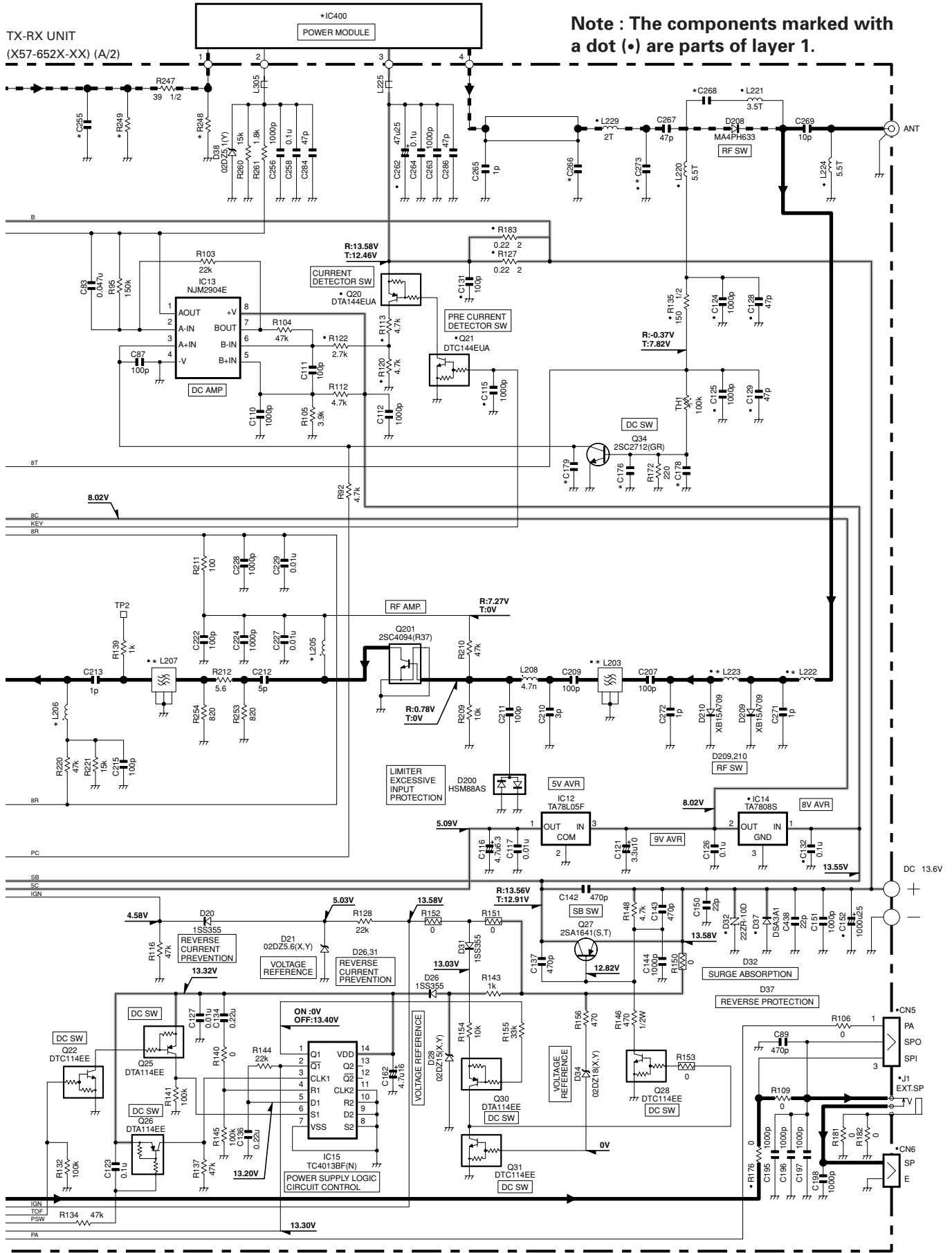

X57-652X-XX	IC400	L203	L205	L206	L207	L222	L223	R248	R249	C176	C178	C179	C255	C266	C268	C273
0-10	TK-980	RA20H8087M	L79-1465-05	8.2n	8.2n	L79-1465-05	L34-1307-05	L34-1307-05	120(1/2w)	47p	47p	NO	10p	5p	47p	3p
0-11	TK-981	RA20H8994M	L79-1467-05	10n	6.8n	L79-1467-05	L34-1313-05	L34-1313-05	150(1/2w)	100p	NO	100p	4p	2p	1p	2p

X57-652X-XX (A/2) TX-RX UNIT

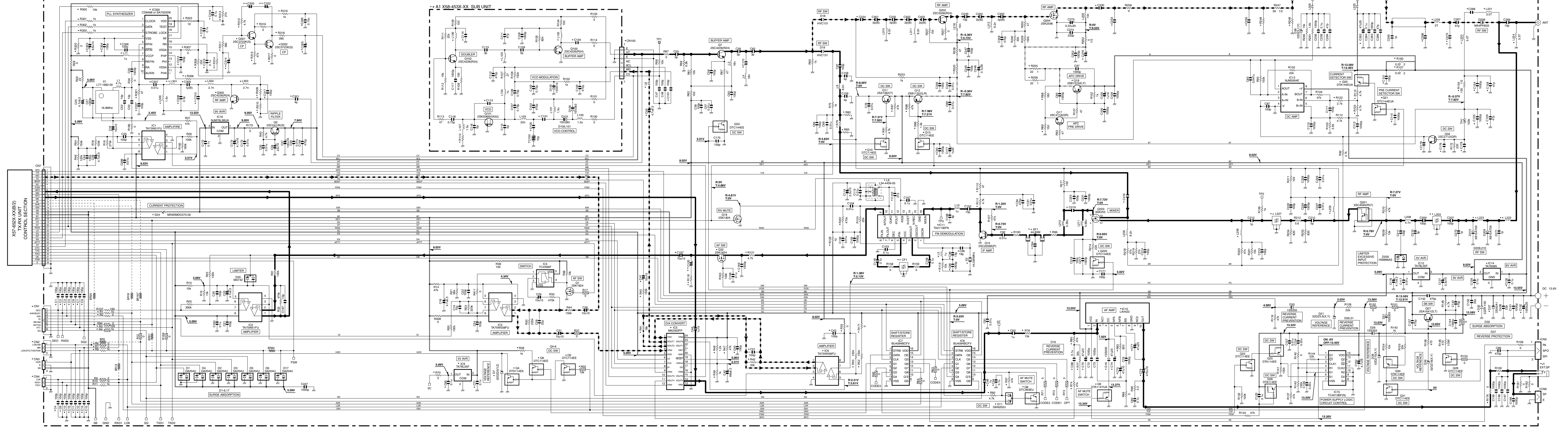

X57-652X-XX	L301	R306	R309	R310	R314	C310	C314	C320	C322	C325
0-10	TK-980	4.7k	1k	33k	10k	22k	2.5p	0.1u35	1u25	1u25
0-11	TK-981	3.9k	470	150k	47k	10k	1.5p	0.068u25	0.47u25	0.47u25

X58-453X-XX	C101	C104	C105	C113	C114	R110	L102	L105	L106	
0-10	TK-980	5p	1.5p	5p	4p	1000p	220	12h	39h	27h
0-11	TK-981	4.5p	1p	4p	470p	180	10h	18h	15h	

X57-652X-XX	A1	R118	C100	C170	
0-10	TK-980	X58-4530-10	3.9k	10u10	7p(B)
0-11	TK-981	X58-4530-11	NO	NO	5p

X57-652X-XX	XF1	CF1	R79	R82	R83	R86	R100	R333	C84	C216	C219	C234	C253	C276	C330	
0-10	TK-980	L71-0525-05	L72-0998-05	39	150	150	330	330	47	12p	1.5p(B)	11p	15p	5p	4.7u20	47p
0-11	TK-981	L71-0583-05	L72-0986-05	18	270	270	180	150	68	22p	1p(B)	12p	100p	5p	2.2u20	15p

X57-652X-XX	IC400	L203	L205	L206	L207	L222	L223	R248	R249	C176	C178	C179	C255	C266	C268	C273
0-10	TK-980	RA20H807M	L79-1465-05	8.2n	8.2n	L79-1465-05	L34-1307-05	L34-1307-05	L201(L2w)	47p	47p	NO	10p	5p	47p	3p
0-11	TK-981	RA20H894M	L79-1467-05	10n	6.8n	L79-1467-05	L34-1313-05	L34-1313-05	150(L2w)	100p	NO	100p	4p	2p	1p	2p

TK-980/981

KENWOOD CORPORATION

2967-3, Ishikawa-machi, Hachioji-shi, Tokyo, 192-8525 Japan

KENWOOD U.S.A. CORPORATION

P.O. BOX 22745, 2201 East Dominguez Street, Long Beach, CA 90801-5745, U.S.A.

KENWOOD ELECTRONICS CANADA INC.

6070 Kestrel Road, Mississauga, Ontario, Canada L5T 1S8

KENWOOD ELECTRONICS DEUTSCHLAND GMBH

Rembrücker Str. 15, 63150 Heusenstamm, Germany

KENWOOD ELECTRONICS BELGIUM N.V.

Leuvensesteenweg 248 J, 1800 Vilvoorde, Belgium

KENWOOD ELECTRONICS FRANCE S.A.

13, Boulevard Ney, 75018 Paris, France

KENWOOD ELECTRONICS U.K. LIMITED

KENWOOD House, Dwight Road, Watford, Herts., WD18 9EB United Kingdom

KENWOOD ELECTRONICS EUROPE B.V.

Amsterdamseweg 37, 1422 AC Uithoorn, The Netherlands

KENWOOD ELECTRONICS ITALIA S.p.A.

Via G. Sirtori, 7/9 20129 Milano, Italy

KENWOOD IBERICA S.A.

Bolivia, 239-08020 Barcelona, Spain

KENWOOD ELECTRONICS AUSTRALIA PTY. LTD.

(A.C.N. 001 499 074)

16 Giffnock Avenue, Centrecourt Estate, North Ryde, N.S.W. 2113 Australia

KENWOOD ELECTRONICS (HONG KONG) LTD.

Unit 3712-3724, Level 37, Tower one Metroplaza, 223 Hing Fong Road, Kwai Fong, N.T., Hong Kong

KENWOOD ELECTRONICS SINGAPORE PTE LTD.

1 Ang Mo Kio Street 63, Singapore 569110